



FORD & DOONAN
Air Conditioning Systems

Operating Instructions

for your Ford & Doonan Ducted System



Congratulations!

Congratulations on your new Ford & Doonan Air Conditioning System. You can rest assured you have received a system of the highest quality, backed by the very best customer service. Before operating the air conditioner, please read this operating manual carefully. It will advise you on how to operate the unit correctly, understand the air conditioner's advanced features and help you in the unlikely event that a problem should occur.

Please keep this manual in a safe place for future reference.

Thank you
for purchasing
Ford & Doonan
Air Conditioning



FORD & DOONAN
Air Conditioning Systems

Contents

1. Important Safety Instructions	4
2. Zone Operation.....	5
3. Outlets.....	6
4. Maintenance.....	7
5. Common Queries.....	8
6. Performance Expectations	9
7. Performance Tips.....	10-11



Scan to view our Operation Videos on our website or visit fordanddoonan.com.au/operation-videos-and-manuals

1. Important Safety Instructions

Never remove any fixed covers on the indoor or outdoor unit. Removal of the covers may expose fast moving fan blades or electrical components operating at a hazardous voltage. Contact with the blades or high voltage components may result in injury or electric shock.

Never insert any objects into the openings of the indoor or outdoor unit. This may damage the product or result in injury to the person inserting the object.

Do not expose the indoor unit or remote controller to rain or moisture. Water or other fluids on the electrical components may result in fire or electric shock.

Always replace any blown fuse with a fuse of the same specification. The use of the

wrong fuse may allow the electrical wiring to overheat and catch on fire. If the correct type of fuse continues to blow, or the circuit breaker continues to trip, contact Ford & Doonan Service Department.

Never operate the air conditioner without the return air filter(s) in place. Operating the unit without the filter(s) will allow dust to enter the indoor unit and build up on the heat exchanger coil and fan motor. This will cause a malfunction of the unit, which will not be covered by warranty.

This electrical appliance is not intended for use by young children. Young children should be supervised to ensure that they do not play with the outdoor unit.



Main switch

Ensure you are familiar with the location of the main switches for the air conditioning system. These switches are normally located adjacent to the outdoor unit and in the fuse box/switchboard.

If the air conditioner is not going to be used for an extended period of time or you are going away on holidays, the main

switch should be turned off to prevent accidental operation of the air conditioner. When turning the system back on, the main switch must be turned on at least 6 hours before the air conditioner is operated to warm up the compressor. Failure to do so may result in damage to the compressor, which will not be covered by warranty.

2. Zone Operation

Applicable when your new system has zones fitted

- For operational instructions please refer to the attached sub manual (if applicable).
- It is possible to run all zones at the same time, however, the system will not be running very efficiently.
- You may operate two or more zones at once, depending on the capacity of your unit, design and heat load. For example, under maximum heat load (a hot day) it is better to have fewer zones on than under a low heat load (at night) when an extra zone may be turned on.
- We recommend turning on the living areas during the day and closing any bedrooms and other zones that are not needed. At night it is best to turn off any living areas and keep the bedroom zones open. This will allow the best efficiency of the system.
- The zones can take up to 2 minutes to open or close.
- If some zones do not have enough air flow check how many zones are open. Close off any zones that are not needed and see if air flow increases.



3. Outlets

Multi-Directional outlets

Multi-Directional outlets (if applicable) are designed to give maximum adjustment to airflow. Each of the four cores (called louvre panels) is adjustable by lifting and turning to direct air from one direction to another. For the distribution of cool air, the louvre panels are set to deflect air horizontally across the ceiling. For high ceilings and heating systems the louvre panels are adjusted to achieve 40% downward flow. For spot cooling and heating, the louvre panels oppose each other for a vertical down airflow. The outlets can be manually closed during winter if the

system is not used for heating, although this is not a necessity.

Sidewall registers

Sidewall registers (if applicable) have vertical and horizontal blades that are adjustable. The blades are manufactured not to rattle. Any adjustments are required to be done with the assistance of long nose pliers with insulation tape wrapped around the ends so the paint of the register is not damaged. Gently move the blades to the desired position.

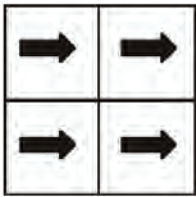

ONE WAY

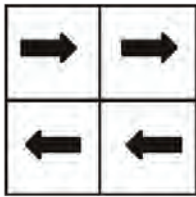

TWO WAY

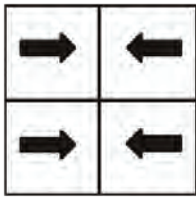

TWO WAY

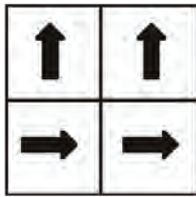

TWO WAY

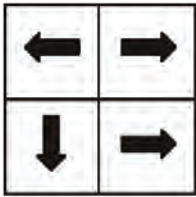

THREE WAY

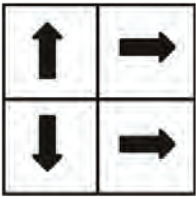

THREE WAY

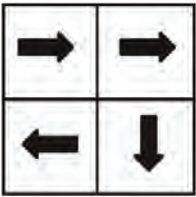

THREE WAY

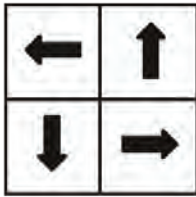

FOUR WAY



4. Maintenance

1. Cleaning the air filter

If you have a clean air filter pack, please call your Ford & Doonan store to purchase a replacement filter. We recommend replacing the filter every 12 months, if you have allergies or pets, we recommend replacing the filter every 6 months.

To clean your filter, remove the filter, hose it down and leave it a couple of hours to dry. Once this is done do not forget to press the filter reset button on your air conditioning controller.

2. Cleaning the outside panel

Cleaning of the outside panel is easy, by using a soft cloth or a cloth dampened by a neutral detergent solution. Never use paint thinner, other chemical products, or polishing powder when cleaning the outside panel. A good quality car polish can be applied to the painted surfaces to increase the paint's durability.

3. When the unit is not being used for an extended period

- Switch off the main power switch.

- Rust preventative coating has been applied to the outside cover. If corroded, repair by painting.
- Clean the condenser to remove dust and excess waste (leaves, paper, etc.).

4. Maintenance service contract recommended

To ensure your system delivers cool, fresh air throughout the year and that your warranty is valid, it's essential you maintain it regularly. Preventative maintenance by qualified technicians has been proven to reduce the risk of failure of plant and equipment and maintain the efficiency of the overall installation.

Servicing by a qualified Ford & Doonan technician is recommended. For domestic operation of the air conditioning system we recommend an annual service. If equipment is subjected to heavy use a bi-annual service frequency is desirable.

Contact your Service Department (9331 8800) to set up automatic service reminders and ask about our three year service packages at a reduced cost.

We recommend replacing your disposable filter every 12 months



DISPOSABLE filter

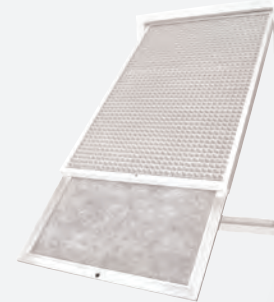

WASHABLE filter

5. Common Queries

If the air conditioning is not running or the cooling effect cannot be achieved as desired, check the following points before requesting repair or service.

If the air conditioner does not function please check the following:

Is the power switched ON?

Has the power fuse failed?

Is power supplied?

Has the circuit breaker tripped?

Is the temperature indicator set in the correct operating position, or to a position which is too high for the cooling operation?

How to perform a reboot of your air conditioning system

Before calling the Service Department please perform a reset of your air conditioning system. As any electrical appliance, power dropouts or surges can interrupt the operation of the system. In most cases a reboot is all that is required. In case the system has never been used before, make sure that the main switch has been turned on for at least 6 hours before using the air conditioning unit.

Locate the isolator switch at the outdoor unit. It is a big white switch at the outdoor unit. Turn it off and wait 3 minutes before turning it back on.

If the system does not reboot, or the fault still appears please call the Ford & Doonan Service Department.

Not cooling or heating as desired please check the following:

Is the thermostat set to the proper position to heating or cooling?

Is there an obstruction near the air intake or outlet port?

Is the air filter free from clogging by dust, dirt, etc.?

Are doors and windows completely closed?

Smoke coming from outdoor unit?

In cold weather you may see what appears to be smoke coming from the unit. This is just steam being released when the unit is in de-ice mode. Further you may notice the unit icing up and appearing frozen. This is normal as long as the system completes a de-ice cycle.

“Filter clean” displays

If a small tap or spanner symbol appears, this indicates it is time to clean or replace the filter. Press this switch to reset and clear the symbol once you have cleaned or replaced the filter. Please see Maintenance for more information on how to clean your filter. If the spanner symbol appears with a fault code, it is advising you of a problem and you will need to contact your Service Department.

Faults:

If the **“CHECK”** indicator starts flashing, this means there is a fault at hand.

In this case, or if fault codes appear, please call your Service Department with the fault code, explain the problem and they will be able to assist with the issue.

6. Performance Expectations

Hot weather

Heat load calculations and manufacturers capacity ratings are based on an outside temperature of 36°C. When the temperature exceeds this, the performance of your air conditioner will fall away the hotter it gets and room temperatures will increase accordingly.

Cold weather

Heat load calculations and manufacturers capacity ratings are based on an outside temperature of 7°C. When the temperature is lower than this, the performance of your air conditioner will fall away the colder it gets and room temperatures will decrease accordingly. The above conditions do occur in Perth and there will be nothing wrong with your air conditioning unit when it happens.

Heating performance

Hot air rises and the room temperatures at different levels will be different. It is normal that some parts of the room will be warmer than others. The same applies on cooling mode but to a lesser degree.

Return air

Your system will usually be designed with one only return air grille. The area around the return air grille will always be drafty, and in Winter, always much cooler than the rooms. This is why we select hallways or other “non occupied rooms”. You will have to leave any room’s entry door ajar to allow the conditioned air to come back to the grille. You cannot close the door as performance will be affected. We have options to overcome these situations, so please discuss this with your consultant.

Zones

If we have installed zones, then they cannot all be turned on together without effecting performance. On low load days or nights your air conditioner can handle a larger area at one time. Your air conditioner can only handle the percentage of the home we mention in our letter at typical design temperatures. Turning on less zones will effectively increase the available capacity you have.



7. Performance Tips

1. Temperature setting on your air conditioning unit

We recommend that in summer you set the cooling cycle at 24 degrees and in Winter the heating at 21 degrees. On very hot days (above 36 degrees) or cold days (below 7 degrees) one can increase the temperature in Summer and decrease in Winter, to keep the efficiency of the air conditioning.

2. To keep the comfortable temperature without extra heat loading

The easiest solution to start your air conditioner earlier in the day by using your timer setting. On hot days start the air conditioner before your heat load increases so the air conditioner can get a head start. On cold days start the air conditioner whilst it is still warm outside (above 12-15°C). This will let the air conditioner deliver maximum capacity before performance falls away. If your system has zones (residential only) reduce the number of zones turned

on when the external conditions are extreme. The smaller the area being air conditioned, the better it can cope.

3. Close doors of rooms that are not being air conditioned

When operating an air conditioning system that utilises the zoning technique, remember the system has only a certain capacity, therefore the idea is to air condition the areas you are occupying at the time. With this in mind, it becomes prudent to habitually close the doors that lead to a non air conditioned area, thereby reducing the total area being subjected to air conditioning. This will enhance the effectiveness of the machine.

4. Allow air flow to return air grille

You will notice that the larger return air grill is normally located in a central position in the building. It is important to encourage the airflow towards this grille. This grille is drawing the total air capacity of the system through it and therefore



requires unrestricted airflow. Depending upon the building, you may need to open or close doors around this area to keep the air flowing to this grille.

5. Regular cleaning of the filter is important

The return air grille in most cases also contains an air filter. This air filter, depending on the system usage and other air quality factors, will need to be cleaned regularly. To do this, simply open the grille and slide out the filter. In most cases it is best to hose the filter clean, although some people prefer to vacuum the filter. Remember, regular cleaning of the filter will improve the system efficiency.

6. Clean outdoor unit and surroundings

The condensing or outdoor unit is located in a position to best suit the building and the occupants. It is important to maintain cleanliness around the unit, for example sweeping away any build-up of leaves or general flotsam. It is critical to not inhibit the airflow coming from the condenser, therefore general garden paraphernalia or other equipment should never be

stacked on or lent against the condenser. Similarly if a garden is developing around the condenser, this can be an advantage as some of the sound from the condensing unit will be absorbed, although a robust bush can block the air flow so consideration should be given to this. It is also imperative to keep the condensing unit accessible for servicing purposes.

7. Sizing of equipment

When we recommend a unit we have completed a heat load calculation on the area. We have assumed the following:

- Curtains will be drawn closed in both sunny Summer days and at night in Winter.
- Ceiling insulation has been installed directly above your ceiling (not just anti-con or sisalation)
- Doors and windows will be left closed.

If any of the above changes, your air conditioner may not be large enough to maintain acceptable room temperatures.

Operating Instructions Timer Remote Controller

Model No. **CZ-RTC4**

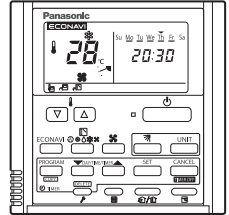

Installation Instructions
Separately Attached.

ENGLISH

Before operating the unit, read these operating instructions thoroughly and keep them for future reference.



Panasonic Corporation
1006 Kadoma, Kadoma City, Osaka, Japan

Panasonic Corporation
<http://www.panasonic.com>

CV6233312187

CONTENTS

Thank you for purchasing the Panasonic timer remote controller.

- Read the Operating Instructions carefully for safe use. This manual describes the Operating Instructions of the timer remote controller. Read this manual as well as operating instructions supplied with indoor units and outdoor units.
- **Be sure to read the “Safety Precautions” (P.3, 4) before using.**
- Keep this manual with operating instructions supplied with indoor units and outdoor units in a safe place.
- Be sure to keep this manual in a place easily accessible by users. In the case of user change, be sure to give this manual to the new user.

NOTICE

The English text is the original instructions. Other languages are translation of the original instructions.

	Page	
<ul style="list-style-type: none"> ● Safety Precautions.....3 ● Part Names5 <ul style="list-style-type: none"> • Control panel5 • Screen display6 		Preparations
<ul style="list-style-type: none"> ● Basic Operations.....7 <ul style="list-style-type: none"> • How to Operate.....7 • Setting the Present Time9 ● Weekly Program Function.....10 <ul style="list-style-type: none"> • Checking the Weekly Timer10 • Changing the Program Timer.....11 • Deleting the Program Timer.....13 • Invalidating the Program Timer.....14 • Duplicating the Program Timer15 • Before Asking Repare work16 		How to Use
<ul style="list-style-type: none"> ● Outing Function17 <ul style="list-style-type: none"> • Setting the Outing Function18 ● Sleeping Function.....19 ● ECONAVI Function.....22 <ul style="list-style-type: none"> • ON/OFF setting of ECONAVI function ...23 		Setting Change
<ul style="list-style-type: none"> ● Troubleshooting24 ● Specifications.....26 		When Necessary

Safety Precautions



WARNING

This symbol refers to a hazard or unsafe practice which can result in severe personal injury or death.



CAUTION

This symbol refers to a hazard or unsafe practice which can result in personal injury or product or property damage.



Matters to be observed



Prohibited matters



WARNING



Do not use this appliance in a potentially explosive atmosphere.



In case of malfunction of this appliance, do not repair by yourself. Contact the sales or service dealer for repair.



In case of emergency, remove the power plug from the socket or switch off the circuit breaker or the means by which the system is isolated from the mains power.



CAUTIONS



This appliance is intended to be used by expert or trained users in shops, in light industry and on farms, or for commercial use by lay persons.

This appliance can be used by children aged from 8 years and above and persons with reduced physical, sensory or mental capabilities or lack of experience and knowledge if they have been given supervision or instruction concerning use of the appliance in a safe way and understand the hazards involved.



- Do not operate with wet hands.
- Do not wash with water.

Safety Precautions

Note:

- This device complies with Part 15 of the FCC Rules. Operation is subject to the following two conditions: (1) This device may not cause harmful interference, and (2) this device must accept any interference received, including interference that may cause undesired operation.
- This equipment has been tested and found to comply with the limits for a Class B digital device, pursuant to Part 15 of the FCC Rules. These limits are designed to provide reasonable protection against harmful interference in a residential installation. This equipment generates, uses and can radiate radio frequency energy and, if not installed and used in accordance with the instructions, may cause harmful interference to radio communications. However, there is no guarantee that interference will not occur in a particular installation. If this equipment does cause harmful interference to radio or television reception, which can be determined by turning the equipment off and on, the user is encouraged to try to correct the interference by one or more of the following measures:
 - Reorient or relocate the receiving antenna.
 - Increase the separation between the equipment and receiver.
 - Connect the equipment into an outlet on a circuit different from that to which the receiver is connected.
 - Consult the dealer or an experienced radio/TV technician for help.
- FCC Caution: To assure continued compliance, follow the attached installation instructions. Any changes or modifications not expressly approved by the party responsible for compliance could void the user's authority to operate this equipment.

Part Names

Control panel

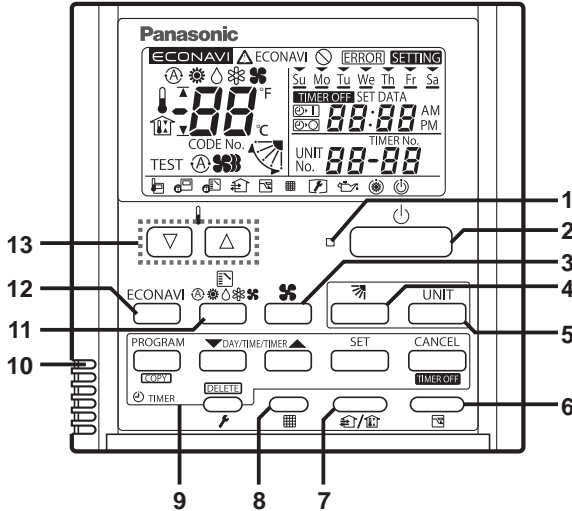

- 1 Operation indicator**
Illuminates during operation. Blinks during alarm.
- 2 Start/Stop button**
Starts/Stops operation.
- 3 Fan speed**
Changing the fan speed.
- 4 Swing/Air direction**
Use this button to set the auto swing or air direction to a specific angle.
- 5 Unit select**
When more than one indoor unit is operated by one remote control unit, this button is used to select a unit when adjusting the air direction.
- 6 Sleeping**
- 7 Ventilation**
Use this button when you installed a fan available in the market. Pressing this button turns on and off the fan. When turning off the air conditioner, the fan will be also turned off.
- 8 Filter reset**
Use this button to reset the filter sign. When  is displayed, press this button after cleaning the filter.
- 9 Timer setting buttons**
- 10 Remote control sensor**
Normally, the temperature sensor of the indoor unit is used to detect the temperature. However, it is also possible to detect the temperature around the remote control unit.
- 11 Mode select**
Pushing this button selects an operation mode.
- 12 ECONAVI**
Use this button to turn on/off the ECONAVI Function.
- 13 Temperature setting buttons**
Changing the temperature setting.

Part Names

Screen display

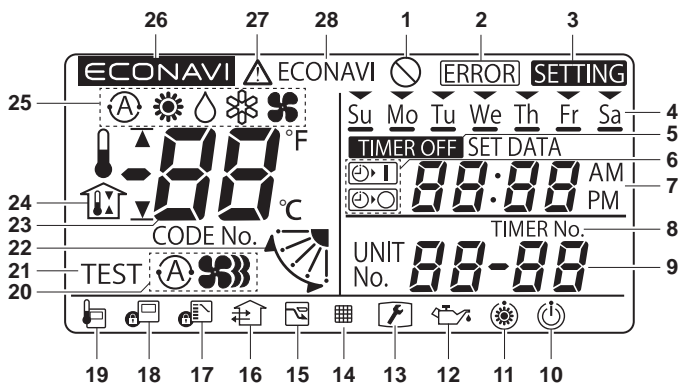





- 1 Displayed if the selected feature was disabled during installation.
- 2 Displayed when a mistake is made during timer setting.
- 3 Appears when the timer program is being set.
- 4 Indicates today's day of the week.
- 5 Displayed when the timer has been turned OFF.
- 6 Timer program indication
: The indoor unit starts operation at the programmed time.
: The indoor unit stops operation at the programmed time.
- 7 Displays the present time on a 24-hour clock. Also, displays settings in the various setting modes.
- 8 Appears when the time program is being set.
- 9 Indicates the unit No. of the selected indoor unit.
- 10 Appears during the peak cut mode (Demand) if an electric heat pump (EHP) air conditioner is used or during standby if a gas heat pump (GHP) air conditioner is used.
- 11 Appears when the fan of the indoor unit is stopped or in low fan speed.
- 12 The engine oil needs to be replaced. (Only when using a gas heat pump air conditioner.)
- 13 Appears when the maintenance function (monitoring sensor temperatures) is activated.
- 14 The indoor unit filter needs to be cleaned.
- 15 Appears during the sleeping function.
- 16 Appears when a fan available in the market is installed and is operating.
- 17 Switching operation modes is prohibited. (Switching to Auto mode is also prohibited.)
- 18 Remote control operation is restricted by a central control device.
- 19 Appears when the remote control sensor is used.
- 20 The selected fan mode is displayed.
 (AUTO /HEAT /DRY /COOL /FAN)
- 21 Appears while in test operation.
- 22 Indicates the flap position.
- 23 Indicates the set temperature.
- 24 Appears during the outing function.
- 25 Displays the selected operation mode.
 (AUTO /HEAT /DRY /COOL /FAN)
- 26 Appears when ECONAVI is being set to ON.
- 27 When inspection is required.
- 28 Appears with displaying 27 if there is a problem on ECONAVI.

Basic Operations

How to Operate

Turn on the indoor unit before operation. See operating instructions of the indoor unit.

Start/Stop operation / Operation mode

1. Press [Start/Stop] to start operation.
2. Press the mode select button to select the mode among AUTO , HEAT , DRY , COOL  and FAN .

* Auto: The mode is automatically switched to Cool or Heat to achieve the set temperature.

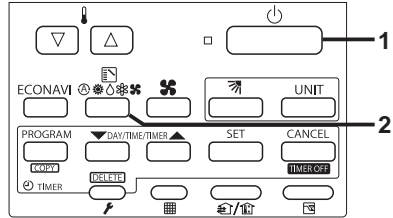

Set temperature

Press [∇/Δ] to set the desired temperature.

Cannot be set in Fan mode.

Temperature

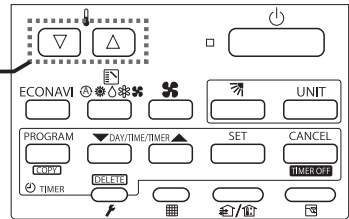

Fan speed

Press the fan speed button to set the fan speed.

: Automatically switches the fan speed.

: Low

: Medium

: High

Fan speed

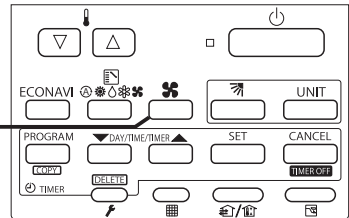



Flap

Press the flap button to adjust the flap position.

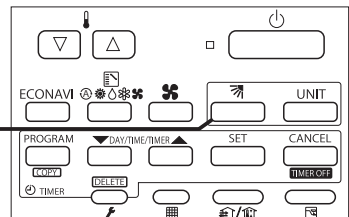
Flap



Note

- If the heating performance is insufficient in Low  fan speed, change the fan speed to Medium  or High .
- The temperature range that can be set varies depending on the model.
- Temperature sensor detects temperature in the vicinity of the air inlet of the indoor unit. The detected temperature slightly differs from the room temperature depending on the installation condition. The set temperature is a guideline of room temperature.

Basic Operations

Setting the Present Time

- 1 Press and hold [SET] for more than 2 seconds to enter the present day and time setting mode.**

Once you enter the setting mode, “SETTING”, “▼”(day) and “time” flash.

- 2 Set “▼” to today’s day of the week.**

Press [▲] to move “▼” (flashing on the display) in the order of: Su → Mo → Tu →
Press [▼] to move it in the order of: Su → Sa → Fr →
Press [SET] to store.

- 3 Press [▼/▲] to change the present “hour” in the range of 0 to 23*1.**

Set the present hour and press [SET].
The “hour” digits light up, and the “minute” digits start flashing.

*1 If the clock uses the 12 hours AM/PM setting, the hour is displayed in the range of AM 1 to 12 / PM 1 to 12.

- 4 Press [▼/▲] to change the present “minute” in the range of 0 to 59.**

Set the present minute and press [SET]. The day and time are set and the unit finishes the setting mode.

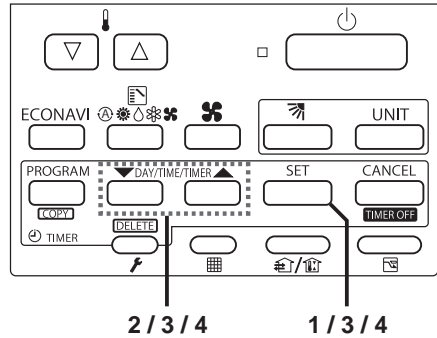

Note

- If the present time is invalid, “- : -” is displayed. If the power failure occurs, check if the set data of day and time are valid.

Weekly Program Function

Checking the Weekly Timer

- Set the weekly program assigning a given timer to each day of the week. Maximum of 6 programs a day and 42 programs a week can be set. Select the day and the TIMER number you want to program.

1 Press [PROGRAM] to enter the program confirmation mode “CH” and start setting.

Once you enter the program confirmation mode, the present day is indicated as TIMER No. “1”.

2 Select the day.

Press [▼/▲] to move the “▼” horizontally on the day to select.

Press [▲] to move “▼” (flashing on the display) in the order of: Su → Mo → Tu...

Press [▼] to move it in the order of: Su → Sa → Fr...

“-- : --” is displayed when the program is not set.

Press [SET] to fix the day.

3 Select a Timer number.

Press [▼/▲] to select a TIMER No. from 1 to 6.

Press [▲] to move up from 1.

Press [▼] to move down from 6.

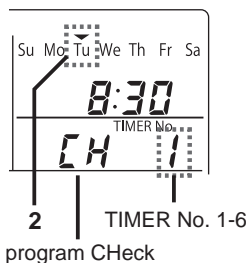
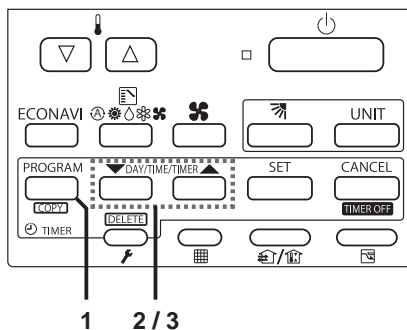

Weekly Program Function

Changing the Program Timer

To set the weekly program, follow the steps.

- 1 Select the program you want to set in the program confirmation mode, and press [SET]. This enters the setting mode of the program currently displayed.**

* In the program setting mode, [SETTING], "hour", "minute" and "item" flash on the display.

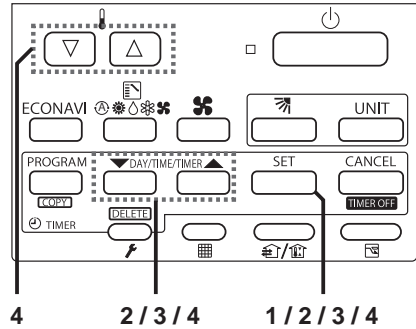

- 2 Set the "hour". (Program step 1)**

Press [▼/▲] to set the "hour". Confirm the "hour" and press [SET]. This enters the program changing mode **P2** (setting of the "minute").

Program step1

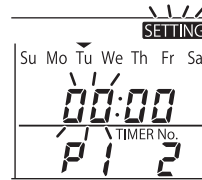

- 3 Set the "minute". (Program step 2)**

Press [▼/▲] to set the "minute". Confirm the "minute" and press [SET]. The unit enters **P3** (the program pattern selection mode).

Program step2

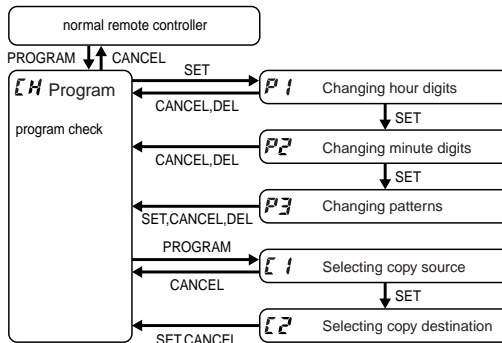
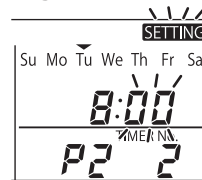

4 Set the program pattern. (Program step 3)

There are 4 program patterns.

Pressing [▼/▲] repeats the following display patterns.

Pattern 1 (Default display)

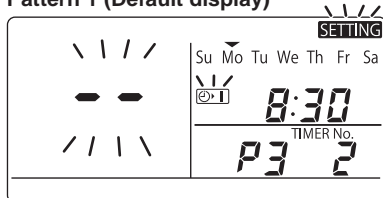

The indoor unit starts operation at the programmed time.

Pattern 2

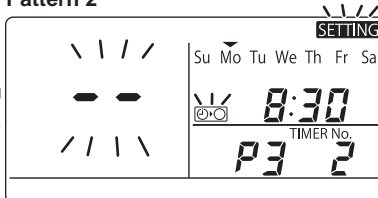

The indoor unit stops operation at the programmed time.

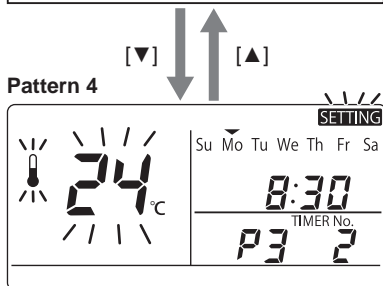

The indoor unit starts operation at the programmed time and changes the temperature settings.

Pattern 3

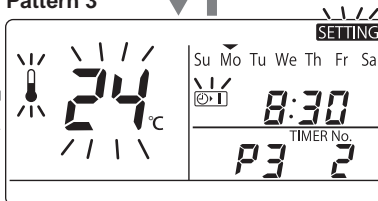

The indoor unit changes the temperature setting at the programmed time.

For **Pattern 3** and **Pattern 4**: Press [▼/▲] to change the temperature setting.

5 Select the program pattern and press [SET].

The program timer setting is confirmed and the unit enters the confirmation mode **CH**.

Note

- If you press [CANCEL] during the setting, it returns to the program confirmation mode.
- If there is no operation made for 10 minutes during the setting, it returns to the normal mode.
In this case, all the settings in progress will be invalid.

Weekly Program Function

Deleting the Program Timer

To delete the program timer setting, follow the steps below.

- 1** Press **[PROGRAM]** to enter the program confirmation mode.
- 2** Press **[▼/▲]** to select the day of the program you want to delete.
Press **[SET]** to fix the day.
- 3** Press **[▼/▲]** to select a **TIMER No.** (from 1 to 6).
- 4** Press **[SET]** to display the program setting mode **P 1**.
- 5** Press **[DELETE]** to delete the program.

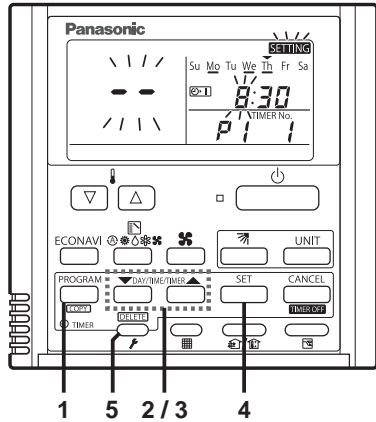

Note

- After deleting, the unit returns to the program confirmation mode **PH**.
- If you press **[CANCEL]** during the setting, the unit returns to the program confirmation mode.
- If there is no operation made for 10 minutes during the setting, the unit returns to the normal mode.

Weekly Program Function

Invalidating the Program Timer

If you want to stop the program operation for more than 1 week, you can invalidate all the timer settings.

Once the timer settings are invalidated, the program will not be operated until the invalidation is cancelled.

How to invalidate the program timer

1. Press and hold [CANCEL]([TIMER OFF]) for more than 2 seconds.
[TIMER OFF] is displayed and the programs will be invalidated from the next one.

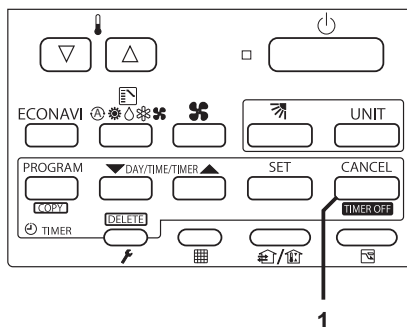

How to cancel the program timer invalidation

1. Press and hold [CANCEL]([TIMER OFF]) for more than 2 seconds.
[TIMER OFF] disappears and the programs will be validated from the next one.

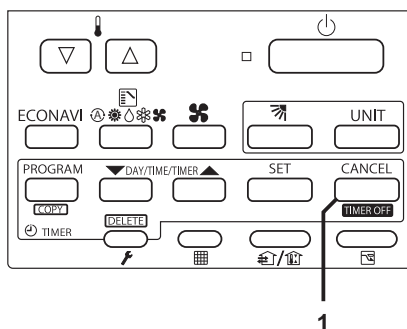

■ If Power Failure Occurred

If the power recovers in a short time period, the program after the recovered time will be valid.

If more than one hour has passed for power return after power failure, the present time information will be lost. In this case, the program will not be operated.

Weekly Program Function

Duplicating the Program Timer

You can duplicate the preset program by day.

■ Select the copy source.

- 1 If [PROGRAM]([COPY]) is pressed in program checking mode $\llbracket H \rrbracket$, it enters the copy mode (Selecting the copy source $\llbracket I \rrbracket$) of the program timer.

While in the copy mode of the program timer, [SETTING] and \blacktriangledown (day) of the copy source flash on the display.

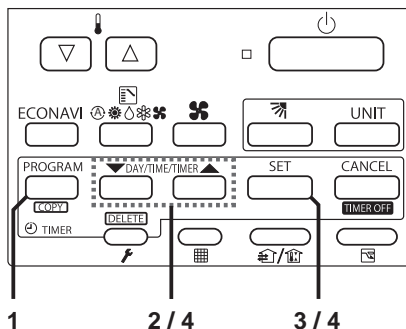

- 2 Press [\blacktriangledown / \blacktriangle] to select the day of the copy source.

Select the copy destination.

- 3 If [SET] is pressed in the mode of selecting the copy source $\llbracket I \rrbracket$, it enters the copy mode (Selecting the copy destination $\llbracket 2 \rrbracket$) of the program timer.

- 4 Press [\blacktriangledown / \blacktriangle] to select the day of the copy destination. Then, press [SET] to complete copying and return to the program checking mode.

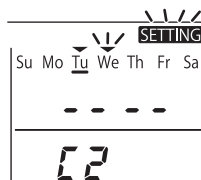
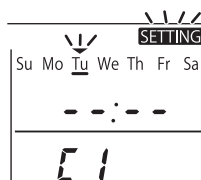

Note

The program will be overwritten if the preprogrammed day is selected as a copy source.

Weekly Program Function

Before Asking Repair Work

Before asking repair work, please check the following.

Trouble	Possible Cause/Remedy
"ERROR" is displayed when the minute digits are entered.	If there is another TIMER No. which has the program of the same time and same day, you cannot overlap the setting.
The set data is not stored.	The stored programs are automatically sorted by the time. Check if the data is stored in the other TIMER No.
Program does not function.	Check if the time indication is not "-- : --". When the time is invalid, the program is also invalid.
	Check the remote controller prohibition inside. In that case, the program is invalid.

Outing Function

Outing function is a function that prevents the room temperature from increasing too much (or decreasing too much) when no one is in the room. An air conditioner works automatically if this function is set effective.

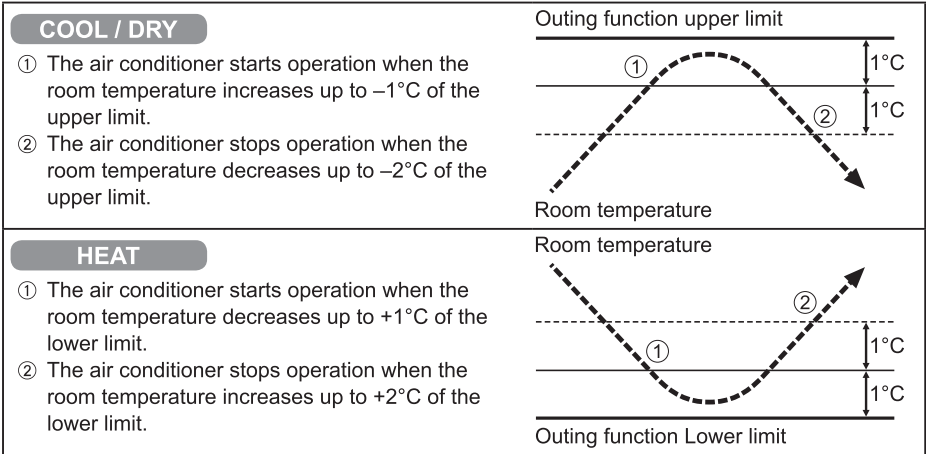

General Performance of the Outing Function



[Precautions]

- The outing control only starts/stops the air conditioner. It does not change the operation mode/temperature setting. Therefore, the operation mode/temperature needs to be set beforehand so that the outing function turns on the air conditioner with your desired operation mode/temperature setting.
 - If the room temperature rapidly changes, the room temperature may get over the upper or lower limit when the outing function is activated.
 - The outing function is invalid during FAN/AUTO operation mode.
 - The air conditioner's stop order (stated in ② / above) is valid only when the outing function is operated.
- If operated using other remote control unit (or a centralized control device such as a system control), the outing function does not work.

• Outing function indication

Outing function indication	Status
Off	The outing function is not set.
Flashing 	The outing function is now being set or under operation.
Lighting 	Although the outing function is set, it is not under operation.



Note

A remote controller may lose outing function operation information when it is cut for more than 24 hours during the outing function operation by electricity. It reverts from the blackout, and an air conditioner does not drive in outing function when operation is started. At this time, an air conditioner does not stop at outing function.

Outing Function

Setting the Outing Function

- 1 Press and hold [Ventilation] for more than 2 seconds to display the upper limit temperature setting screen.

[SETTING], ,  and the upper limit temperature start flashing.
(The default value of the upper limit temperature is 38 °C.)

- 2 Press [∇/Δ] to select the upper limit temperature, and press [SET] to fix the value. The lower limit temperature setting screen is displayed.

- 3 Press [∇/Δ] to select the lower limit temperature, and press [SET] to fix the value. The outing function setting is completed.

(The default value of the lower limit temperature is 10 °C.)

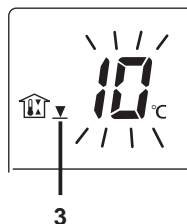
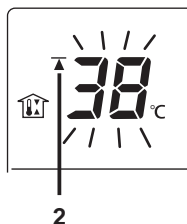
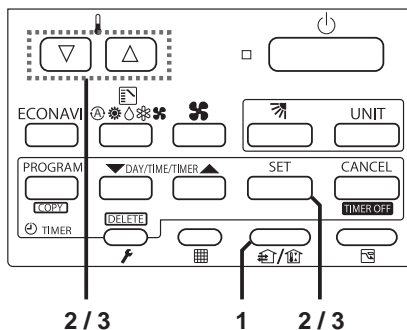

* The unit returns to the normal mode if [CANCEL] is pressed or there is no operation made for 3 minutes during the setting. In this case, all the settings in progress will be lost.

Canceling the outing function

1. Press and hold [Ventilation] for more than 2 seconds while the outing function is set.

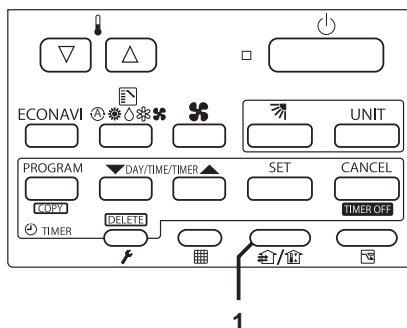

Sleeping Function

This function leads you to a comfortable sleep and changes the room temperature during your sleep.

- You can set the off timer every one hour from 1 to 10 hours.

■ Display of remote control unit (during the time setting)

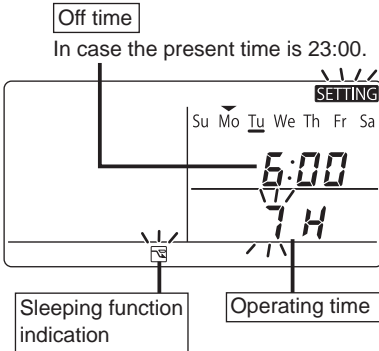

■ Display of remote control unit (during sleeping function setting)

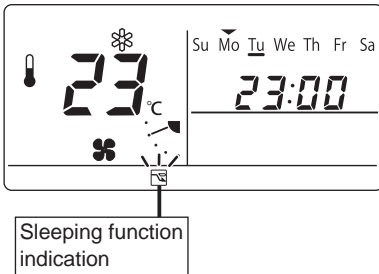

- * If no operation is made for 3 minutes, the time setting mode will be automatically finished.

Ex. In case of 7 hours timer

1 Press [Sleeping].

- Each time the button is pressed, the indication changes in the following order.

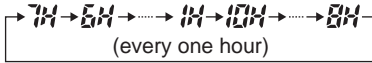

(Press [CANCEL] to stop the time setting.)

2 Press [SET].

- The sleeping operation starts.

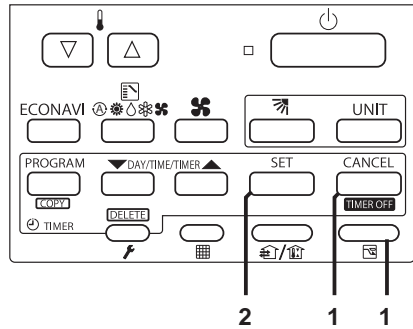

■ When the off time comes:

- The indoor unit stops.
 - * The temperature returns to the setting at the time when sleeping function operation started.

To cancel the sleeping function operation

1. Press [Sleeping].

- * The temperature setting remains at the time cancelled.

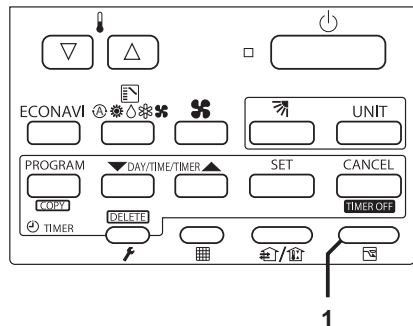

- The following buttons also cancel the sleeping function operation.

[Start/Stop] button

Stops the indoor unit after the sleeping function operation is cancelled.



[Mode select] button

Changes the operation mode after the sleeping function operation is cancelled.

■ If [Sleeping] button does not work.

Or, in the case of operation not being started even if [SET] is pressed.

Check the following table.

Item	Display of the remote control unit (Lighting/flashing indication)	Contents
1	 The Error indication flashes (for several seconds).	The clock is not set.
2	 "This function is not available" indication lights up (for several seconds).	When the operation mode is set to AUTO or FAN, this function is not available.
3	 Centralized control indication flashes (for several seconds).	The centralized control device is prohibited from starting/stopping the unit or changing the temperature setting.

The sleeping function operation will be cancelled in the following cases:

- 1: When the unit is operated to stop or change the temperature setting by the other remote control unit or centralized control device.
- 2: When the unit is operated to stop or change the temperature setting with the weekly program function / outing function.
- 3: When the centralized control unit is prohibited from stopping the unit or changing the temperature setting.

Note

Trouble	Possible Cause/Remedy
The temperature setting does not decrease (increase).	The temperature over the upper or lower limit or each operation mode cannot be set.
Operation under the sleeping function does not finish.	Note if you change the time after the sleeping function started. The operation does not finish until it reaches to the set starting time.

ECONAVI Function

This function is available by attaching an optional ECONAVI sensor.

The ECONAVI sensor detects human activity and conserves energy based on the activity level.

Overview of the ECONAVI function

High activity	<ul style="list-style-type: none">• Cooling: Target temperature is the same as the set temperature.• Heating: Target temperature is 1 °C lower than the set temperature.
Low activity	<ul style="list-style-type: none">• Cooling: Target temperature is 1 °C higher than the set temperature.• Heating: Target temperature is the same as the set temperature.
No one in the room	<p>No one in the room for 20 minutes</p> <ul style="list-style-type: none">• Cooling: Target temperature is 2 °C higher than the set temperature.• Heating: Target temperature is 2 °C lower than the set temperature. <p>No one in the room for 3 hours</p> <ul style="list-style-type: none">• Cooling: Cooling will stop and the unit will be in fan only mode.• Heating: Heating will stop and the unit will be in fan only mode.
* When the sensor detects movements in the room which have been empty, it will resume operation to match with the activity level.	

Note

- Even when target temperature is changed through the ECONAVI function, the set temperature shown in the remote controller does not change.
 - Even when Cooling/Heating is changed to Fan through the ECONAVI function, the operation mode shown in the remote controller will still be Cooling/Heating.
 - It is possible to choose from the following options for the operation to be performed after a lapse of 3 hours since the room has been empty.
 - Operates in the Fan mode only.
 - Stops and resumes operations after human movements are detected.
 - Stops and will not resume operations even after human movements are detected.
 - Continues to operate in the current mode.
- If you need to do so, please contact the dealer.

ECONAVI Function

ON/OFF setting of ECONAVI function

Using the remote controller, you can switch the ECONAVI function ON/OFF.

1 Press [ECONAVI] to ON the ECONAVI function.

* When ECONAVI is enabled, **ECONAVI** will appear.

2 Press [ECONAVI] to OFF.

* When the indoor unit is stopped, **ECONAVI** will disappear.

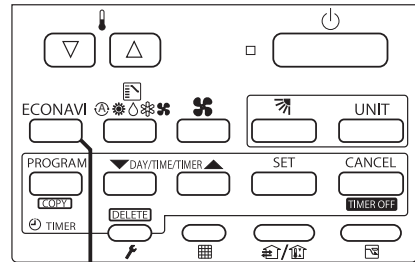

1 / 2

Note

- Turn the ECONAVI function OFF if:
 - You want to maintain the room temperature at a set temperature.
 - You want to keep air conditioner running while nobody is in a room.
 - The sensor fails.
 - Only infants, babies, or people only with disabilities are in the room.





WARNING

Do not use the ECONAVI function in a room with disabled persons or infants only. Due to their limited motions, the ECONAVI sensor may judge no person is present, causing the indoor unit to stop the operation.

Troubleshooting

If operation does not start by pressing [Start/Stop] button ...

Check the following before asking for repair.

<p>Blackout?</p>	<ul style="list-style-type: none">● After recovery from blackout, press [Start/Stop] again.→ If operation does not start, turn off the circuit breaker and consult the dealer of purchase about the symptom and Model No.
<p>Is the circuit breaker turned off?</p>	<ul style="list-style-type: none">● Turn it on and press [Start/Stop] again.→ If operation does not start, turn off the circuit breaker and consult the dealer of purchase about the symptom and Model No.
<p>Is SETTING blinking?</p>	<ul style="list-style-type: none">● After blinking stops, press [Start/Stop] again.→ If operation does not start, turn off the circuit breaker and consult the dealer of purchase about the symptom and Model No.
<p>Is  displayed?</p>	<ul style="list-style-type: none">● If any of the following alarm indications appears, stop operation once and restart approx. 1 minute later. (Alarm indication, off) [●E04 ●E06 ●P10 ●P20 ●H06]→ If the indication does not reappear, use the unit.→ If the indication reappears or an alarm indication other than the above (combination of numbers and characters such as E, F, H, L and P) appears, stop operation, turn off the circuit breaker and consult the dealer of purchase about alarm indication, Model No. and indoor unit No.
<p>Cannot stop the operation. Or the unit starts to run automatically even if [Start/Stop] (Off) is pressed.</p>	<ul style="list-style-type: none">● Check if the outing function is activated or not. ● Check control by central control device.

The remote controller screen displays a flashing “ ECONAVI”.

- Faulty sensor or incorrect installation. Turn OFF the ECONAVI function with the remote controller and contact the retailer or point of purchase with the Model No. and problem.

The remote controller screen does not display the .

- The indoor unit has stopped. Turn on the indoor unit.
- The unit is in Fan mode. The ECONAVI function does not operate in Fan mode.
- The ECONAVI function is set to OFF. Turn the ECONAVI function ON with the remote controller.
- The indoor unit may not support the ECONAVI function. If you turn the ECONAVI function ON with the remote control but there is no change, the indoor unit does not support the ECONAVI function. Please contact the dealer.

- If you need to contact for servicing, check the back cover of the operating instructions for indoor units or outdoor units.

Specifications

Model No.	CZ-RTC4	
Dimensions	(H) 120 mm x (W) 120 mm x (D) 20 + 4.75 mm	
Weight	160 g	
Temperature/ Humidity range	0 °C to 40 °C / 20 % to 80 % (no condensation) *Indoor use only.	
Power Source	DC16 V (supplied with indoor unit)	
Clock	Precision	± 30 seconds/month (at normal temperature 25 °C) *Adjust periodically.
	Holding time	24 hours (when fully charged) *Approx. 8 hours are required for full charge.
Number of connected indoor units	Up to 8 units	